



E32-433T30D User Manual

SX1278 433MHz 1W DIP Wireless Module



CONTENT

1. OVERVIEW.....3

 1.1 INTRODUCTION..... 4

 1.2 FEATURES..... 4

2.SPECIFICATION AND PARAMETER..... 5

 2.1 LIMIT PARAMETER..... 5

 2.2 OPERATING PARAMETER..... 5

3 SIZE AND PIN DEFINITION..... 6

4 CONNECT TO MCU..... 7

5 FUNCTION DESCRIPTION.....8

 5.1 FIXED TRANSMISSION..... 8

 5.2 BROADCASTING TRANSMISSION..... 8

 5.6.1 Indication of UART output..... 9

 5.6.2 Indication of wireless transmitting..... 9

 5.6.3 Configuration procedure of module..... 10

 5.6.4 Notes for AUX..... 10

6 OPERATING MODE.....11

 6.1 MODE SWITCH.....11

 6.2 NORMAL MODE (MODE 0).....12

 6.3 WAKE-UP MODE (MODE 1).....12

 6.4 POWER-SAVING MODE (MODE 2).....12

 6.5 SLEEP MODE (MODE 3)..... 13

7 COMMAND FORMAT..... 13

 7.1 DEFAULT PARAMETERS..... 13

 7.2 READING OPERATING PARAMETERS.....14

 7.3 READING VERSION NUMBER..... 14

 7.4 RESET COMMAND..... 14

 7.5 PARAMETER SETTING COMMAND.....14

8. HARDWARE DESIGN..... 16

9 FAQ.....17

 9.1 COMMUNICATION RANGE IS TOO SHORT..... 17

 9.2 MODULE IS EASY TO DAMAGE..... 18

 9.3 BER(BIT ERROR RATE) IS HIGH.....18

10 PRODUCTION GUIDANCE..... 18

11 E32 SERIES..... 18

12 ANTENNA RECOMMENDATION..... 19

13 PACKAGE FOR BATCH ORDER..... 20



REVISION HISTORY.....	21
ABOUT US.....	21

Disclaimer

EBYTE reserves all rights to this document and the information contained herein. Products, names, logos and designs described herein may in whole or in part be subject to intellectual property rights. Reproduction, use, modification or disclosure to third parties of this document or any part thereof without the express permission of EBYTE is strictly prohibited.

The information contained herein is provided “as is” and EBYTE assumes no liability for the use of the information. No warranty, either express or implied, is given, including but not limited, with respect to the accuracy, correctness, reliability and fitness for a particular purpose of the information. This document may be revised by EBYTE at any time. For most recent documents, visit www.ebyte.com.

1. Overview

1.1 Introduction

E32-433T30D is a wireless serial port module (UART) based on SEMTECH's SX1278 RF chip. It has multiple transmission modes, working in the 410MHz~441MHz, (default 433MHz), LoRa spread spectrum technology,

SX1278 features LoRa™, which will bring longer communication distance, and has the advantages of concentrated power density, meanwhile it has a very strong confidentiality. E32-433T30D is in stable bulk production and are widely applied in utility meters, IoT renovation, smart home, etc. The modules feature data encryption and compression. The data transmitted in air features randomness. air Data Rate (Default 2.4kps). The encryption-decryption algorithm makes data interception meaningless. The data compression enables shorter transmitting time and lower rate of being interfered, which increased the reliability and transmitting efficiency.



1.2 Features

- Communication distance tested is up to 8km
- Maximum transmission power of 1W, software multi-level adjustable;
- Support the global license-free ISM 433MHz band;
- Support air data rate of 0.3kbps~19.2kbps;
- Support new generation LoRa technology.
- Low power consumption for battery supplied applications;
- Support 3.3V~5.2V power supply, power supply over 5.0 V can guarantee the best performance;
- Industrial grade standard design, support -40 ~ 85 °C for working over a long time;
- SMA access point, good for secondary development and integration.

1.3 Application

- Home security alarm and remote keyless entry;
- Smart home and industrial sensors;
- Wireless alarm security system;
- Building automation solutions;
- Wireless industrial-grade remote control;
- Health care products;
- Advanced Meter Reading Architecture(AMI);
- Automotive industry applications.

2. Specification and parameter

2.1 Limit parameter

Main parameter	Performance		Notes
	Min.	Max.	
Power supply (V)	0	5.2	Voltage over 5.2V will cause permanent damage to module
Blocking power (dBm)	-	-10	Chances of burn is slim when modules are used in short distance
Operating temperature (°C)	-40	+85	-

2.2 Operating parameter

Main parameter		Performance			Remark
		Min	Typ.	Max.	
Operating voltage (V)		3.3	5.0	5.2	≥5.0 V ensures output power
Communication level (V)		-	3.3	-	For 5V TTL, it may be at risk of burning down
Operating temperature (°C)		-40	-	85	Industrial design
Operating frequency (MHz)		410	-	441	Support ISM band
Power consumption	Transmitting current [mA]	-	610	Instant power consumption	Instant power consumption
	Receiving current [mA]	-	20	-	-
	Turn-off current [μA]	-	5	-	Software is shut down
Max Tx power (dBm)		29.5	30	30.5	-
Receiving sensitivity (dBm)		-145	-147	-148	Air data rate is 2.4kbps
Air data rate (bps)		0.3k	2.4k	19.2k	Controlled via user's programming

Main parameter	Description	remark
Distance for reference	8000m	Test condition : clear and open area, antenna gain: 5dBi, antenna height: 2.5m, air data rate: 2.4kbps
TX length	58 Byte	Maximum capacity of single package
Buffer	512 Byte	-
Modulation	LoRa™	-
Communication interface	TTL	@3.3V
Package	DIP	-
Connector	2.54mm	-
Size	24 * 43mm	-

Antenna	SMA-K	50 ohm impedance
---------	-------	------------------

3 Size and pin definition

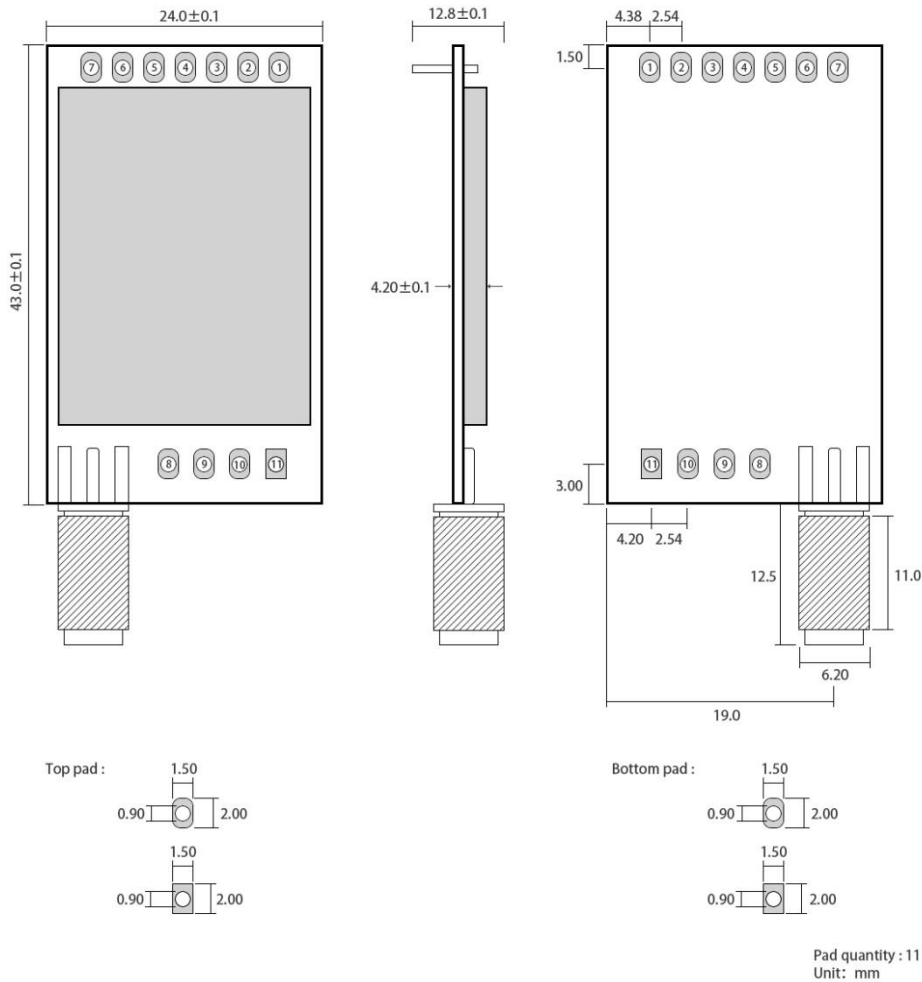

No.	Name	Direction	Function
1	M0	Input (weak pull-up)	Work with M1 to decide 4 working modes of module (not suspended, if not used, could be grounded).
2	M1	Input (weak pull-up)	Work with M0 to decide 4 working modes of module (not suspended, if not used, could be grounded).
3	RXD	Input	TTL UART inputs, connects to external (MCU, PC) TXD output pin. Can be configured as open-drain or pull-up input.
4	TXD	Output	TTL UART outputs, connects to external RXD (MCU, PC) input pin. Can be configured as open-drain or push-pull output
5	AUX	Output	To indicate module 's working status & wakes up the external MCU. During the procedure of self-check initialization, the pin outputs low level. Can be configured as push-pull output

			(suspending is allowed).
6	VCC	Input	Power supply : 3.3~ 5.2V DC
7	GND	Input	Ground
8	fixed orifice	-	fixed orifice
9	fixed orifice	-	fixed orifice
10	fixed orifice	-	fixed orifice
11	fixed orifice	-	fixed orifice

4 Connect to MCU

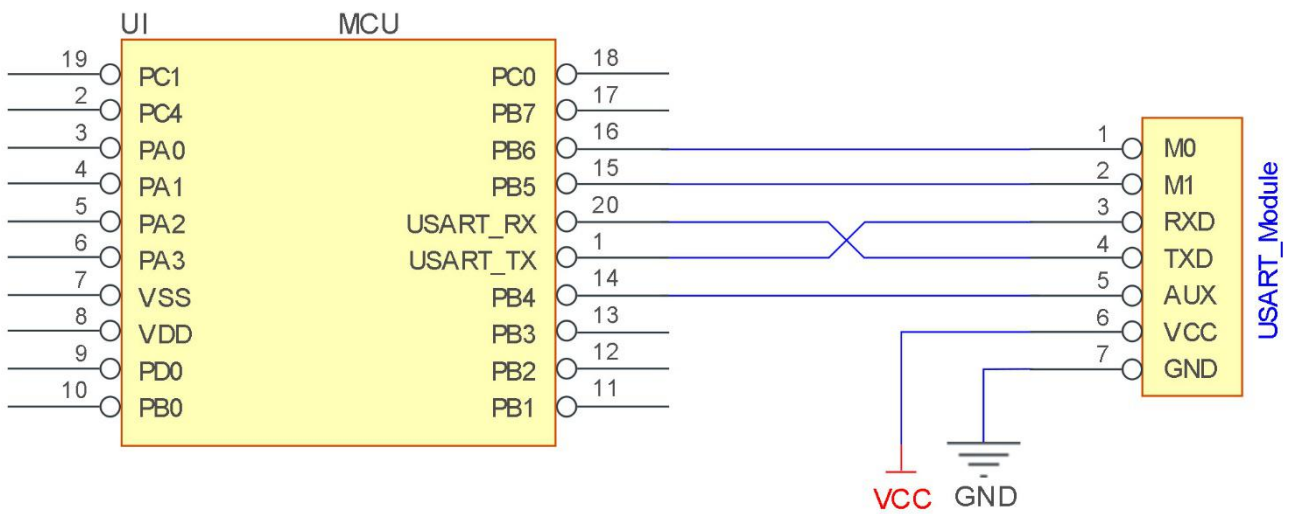

No.	Description (STM8L MCU)
1	The UART module is TTL level.
2	For some MCU works at 5VDC, it may need to add 4-10K pull-up resistor for the TXD & AUX pin.

5 Function description

5.1 Fixed transmission

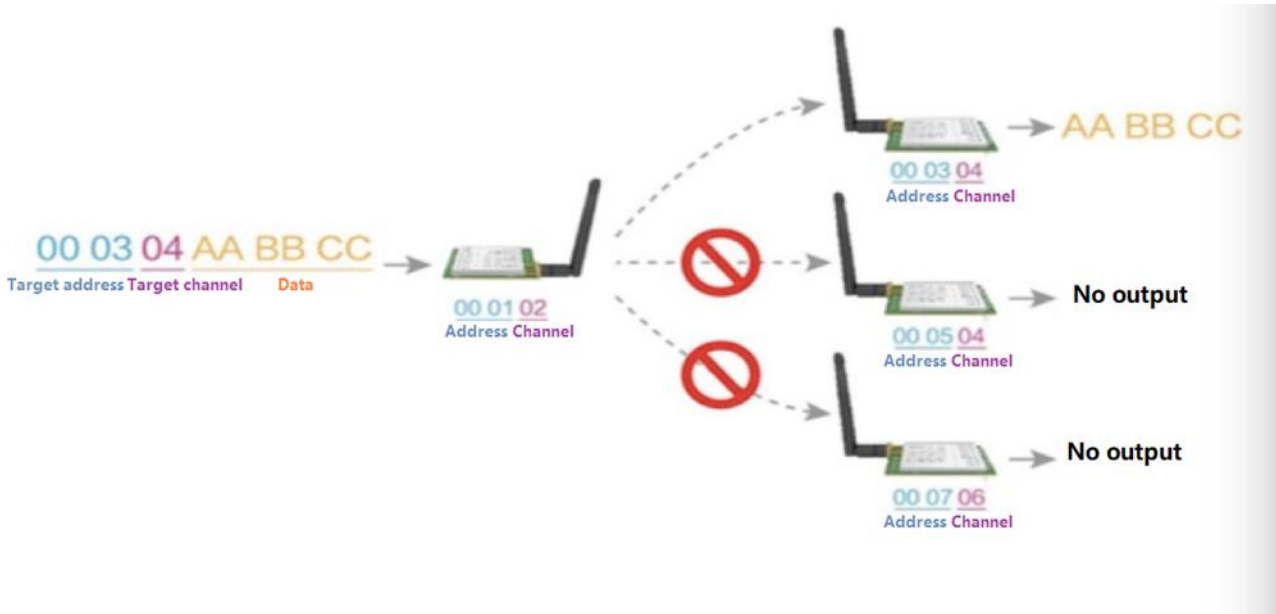

5.2 Broadcasting transmission

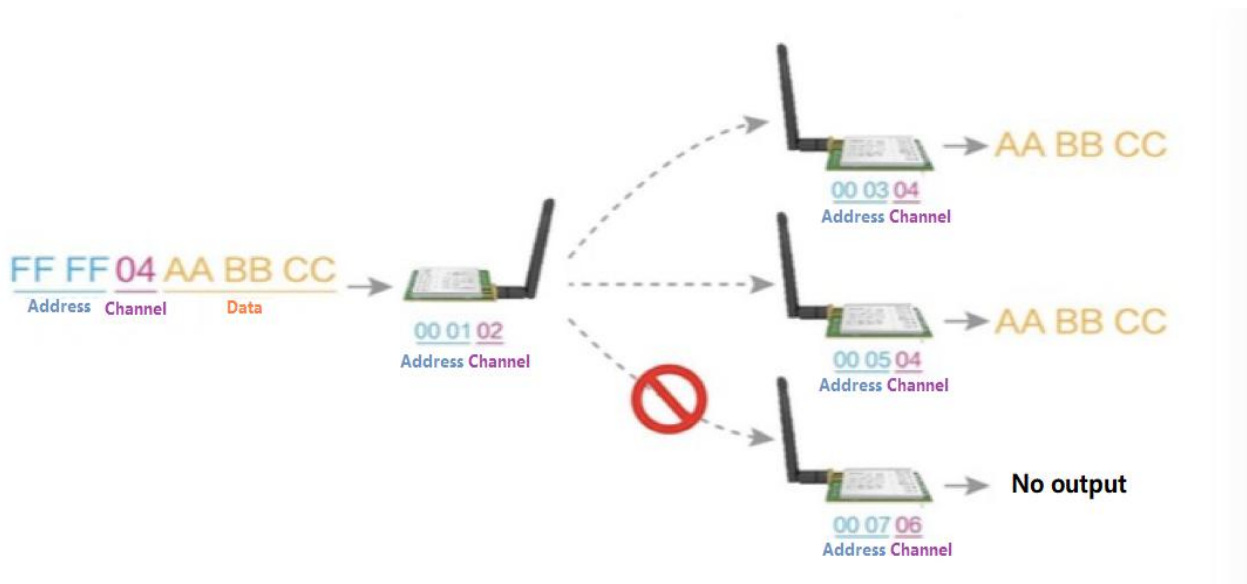

5.3 Broadcasting address

- For example: Set the address of module A as 0xFFFF, and the channel as 0x04;
- When module is the transmitter (transparent transmission), all modules under channel 0x04 will receive the data, the

purpose of broadcast is realized.

5.4 Monitor address

- For example: Set the address of module A as 0xFFFF, and the channel as 0x04;
- When module A is the receiver, it can receive the data sent from all modules under channel 0x04, the purpose of monitor is realized.

5.5 Reset

- When the module is powered, AUX outputs low level immediately, conducts hardware self-check and sets the operating mode based on user's parameters. During the process, the AUX remains low level. After the process completed, the AUX outputs high level and starts to work as per the operating mode combined by M1 and M0. Therefore, users need to wait the AUX rising edge as the start of module's normal work.

5.6 AUX description

- AUX Pin can be used as indication for wireless send & receive buffer and self-check.
- It can indicate whether there are data that are not sent yet via wireless way, or whether all wireless data has been sent through UART, or whether the module is still in the process of self-check initialization.

5.6.1 Indication of UART output

- To wake up external MCU

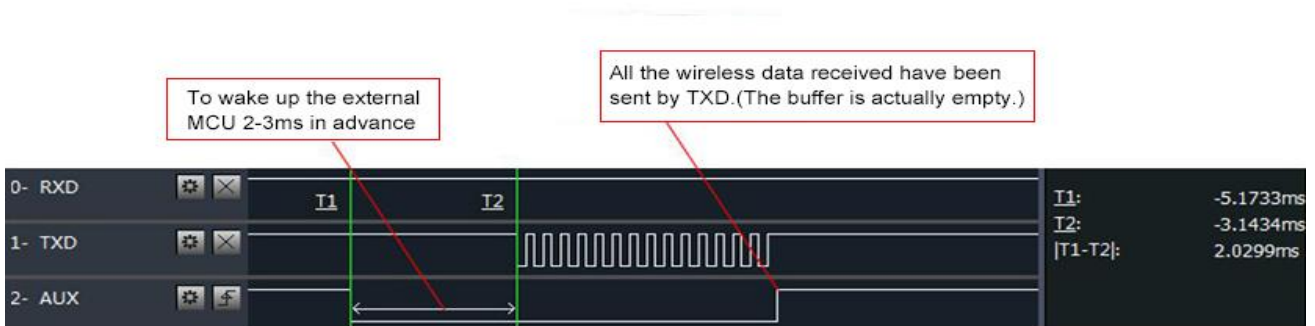

Timing Sequence Diagram of AUX when TXD pin transmits

5.6.2 Indication of wireless transmitting

- Buffer (empty): the internal 512 bytes data in the buffer are written to the RFIC (Auto sub-packaging).
- When AUX=1, the user can input data less than 512 bytes continuously without overflow. Buffer (not empty): when AUX=0, the internal 512 bytes data in the buffer have not been written to the RFIC completely. If the user starts to transmit data at this circumstance, it may cause overtime when the module is waiting for the user data, or transmitting wireless sub package.

- When AUX = 1, it does not mean that all the UART data of the module have been transmitted already, perhaps the last packet of data is still in transmission.

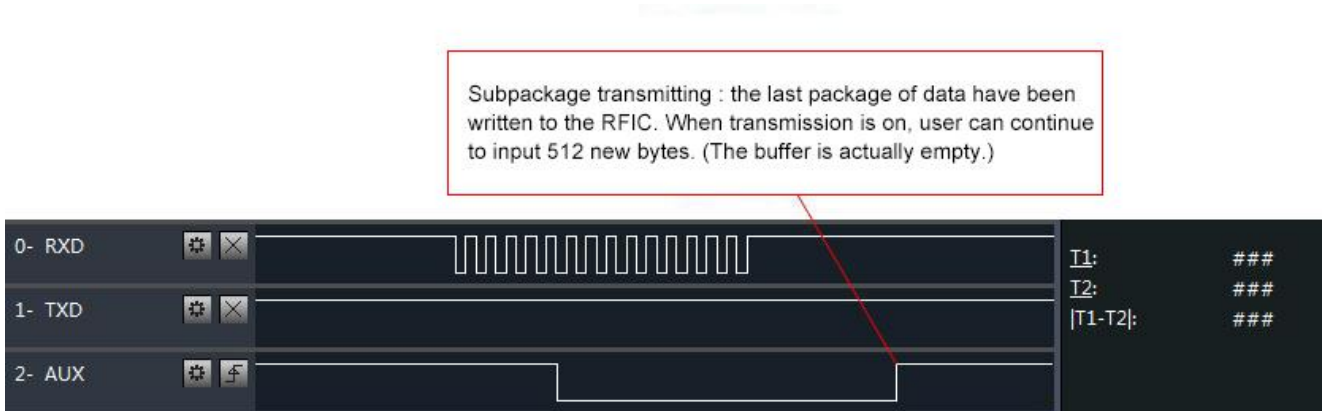

Timing Sequence Diagram of AUX when RXD pin receives

5.6.3 Configuration procedure of module

- Only happened when power-on resetting or exiting sleep mode

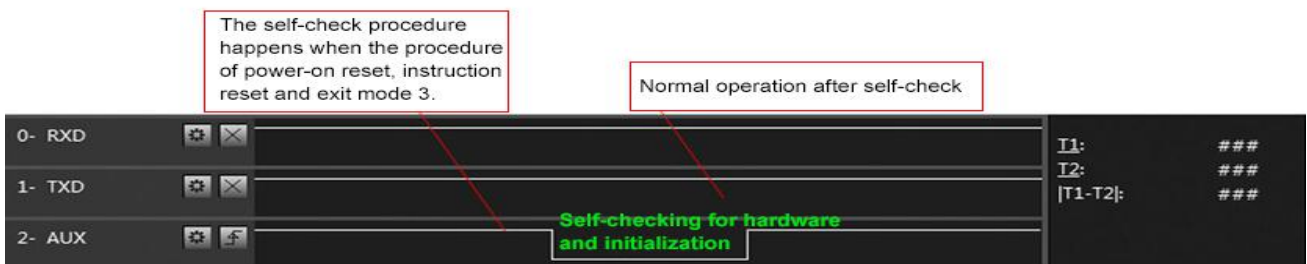

Timing Sequence Diagram of AUX when self-check

5.6.4 Notes for AUX

No.	Description
1	For function 1 & function 2 mentioned above, the priority should be given to the one with low level output, which means if it meets each of any low level output condition, AUX outputs low level, if none of the low level condition is met, AUX outputs high level.
2	When AUX outputs low level, it means the module is busy & cannot conduct operating mode checking. Within 1ms since AUX outputs high level, the mode switch will be completed.
3	After switching to new operating mode, it will not work in the new mode immediately until AUX rising edge lasts for 2ms . If AUX stays on the high level, the operating mode switch can be affected immediately.
4	When the user switches to other operating modes from mode 3 (sleep mode) or it's still in reset process, the module will reset user parameters, during which AUX outputs low level.

6 Operating mode

There are four operating modes, which are set by M1 and M0, the details are as follows:

Mode (0-3)	M0	M1	Mode introduction	Remark
0 Normal	0	0	UART and wireless channel are open, transparent transmission is on	The receiver must work in mode 0 or mode 1
1 Wake up	1	0	UART and wireless channel are open, the only difference with mode 0 is that before transmitting data, increasing the wake up code automatically, so that it can awake the receiver under mode 3.	The receiver could be 0,1 or 2
2 Power saving	0	1	UART close, wireless is under air-awaken mode, after receiving data, UART open and send data.	transmitter must be mode 1, unable to transmit in this mode.
3 Sleep	1	1	sleep mode, receiving parameter setting command is available.	more details on parameter specification.

6.1 Mode switch

- The user can decide the operating mode by the combination of M1 and M0. The two GPIO of MCU can be used to switch mode. After modifying M1 or M0, it will start to work in new mode 1ms later if the module is free. If there are any serial data that are yet to finish wireless transmitting, it will start to work in new mode after the UART transmitting finished. After the module receives the wireless data & transmits the data through serial port, it will start to work in new mode after the transmitting finished. Therefore, the mode-switch is only valid when AUX outputs 1, otherwise it will delay.
- For example, in mode 0 or mode 1, if the user inputs massive data consecutively and switches operating mode at the same time, the mode-switch operation is invalid. New mode checking can only be started after all the user's data process completed. It is recommended to check AUX pin out status and wait 2ms after AUX outputs high level before switching the mode.
- If the module switches from other modes to stand-by mode, it will work in stand-by mode only after all the remained data process completed. The feature can be used to save power consumption. For example, when the transmitter works in mode 0, after the external MCU transmits data "12345", it can switch to sleep mode immediately without waiting the rising edge of the AUX pin, also the user's main MCU will go dormancy immediately. Then the module will transmit all the data through wireless transmission & go dormancy 1ms later automatically, which reduces MCU working time & save power.
- Likewise, this feature can be used in any mode-switch. The module will start to work in new mode within 1ms after completing present mode task, which enables the user to omit the procedure of AUX inquiry and switch mode swiftly. For example, when switching from transmitting mode to receiving mode, the user MCU can go dormancy before mode-switch, using external interrupt function to get AUX change so that the mode-switch can be realized.
- This operation is very flexible and efficient. It is totally designed on the basis of the user MCU's convenience, at the same time the work load and power consumption of the whole system have been reduced and the efficiency of whole system is largely improved.

6.2 Normal mode (mode 0)

When M1 = 0 & M0 = 0, module works in mode 0	
Transmitting	<p>The module can receive the user data via serial port, and transmit wireless data package of 58 bytes. When the data inputted by user is up to 58 byte, the module will start wireless transmission. During which the user can input data continuously for transmission.</p> <p>When the required transmission bytes are less than 58 bytes, the module will wait 3-byte time and treat it as data termination unless continuous data inputted by user. Then the module will transmit all the data through wireless channel.</p> <p>When the module receives the first data packet from user, the AUX outputs low level.</p> <p>After all the data are transmitted into RF chip and transmission start , AUX outputs high level.</p> <p>At this time, it means that the last wireless data package transmission is started, which enables the user to input another 512 bytes continuously. The data package transmitted from the module working in mode 0 can only be received by the module working in mode 0 or 1.</p>
Receiving	<p>The wireless receiving function of the module is on, the data packet transmitted from the module working in mode 0 & mode 1 can be received.</p> <p>After the data packet is received, the AUX outputs low level, 5ms later the module starts to transmit wireless data through serial port TXD pin.</p> <p>After all the wireless data have been transmitted via serial port, the AUX outputs high level.</p>

6.3 Wake-up mode (mode 1)

When M1 = 0 & M0 = 1, module works in mode 1	
Transmitting	<p>The condition of data packet transmission & AUX function is the same as mode 0. The only difference is that the module will add preamble code before each data packet automatically. The preamble code length depends on the wake-up time set in the user parameters. The purpose of the preamble code is waking up the receiving module works in mode 2. Therefore, the data package transmitted from mode 1 can be received by mode 0, mode1 and mode 2.</p>
Receiving	<p>The same as that in mode 0.</p>

6.4 Power-saving mode (mode 2)

When M1 = 1 & M0 = 0, module works in mode 2	
Transmitting	<p>UART is closed, the module cannot receive any serial port data from outside MCU.</p> <p>Hence the function of wireless transmission is not available for the module working in this mode.</p>

Receiving	<p>In mode 2, it is required the data transmitter works in mode 1. The wireless module monitors the preamble code at regular time. Once it gets the preamble code, it will remain as receiving status and waiting for the completion of receiving the entire valid data package. Then the AUX outputs low level, 5ms later the serial port is open to transmit received wireless data through TXD. Finally, AUX outputs high level after process completed. The wireless module stays in “power-saving – monitoring” working status (polling). By setting different wake-up time, the module will have different receiving response delay (2s in maximum) and average power consumption (30uA in minimum). The user needs to achieve a balance between communication delay time & average power consumption.</p>
-----------	---

6.5 Sleep mode (mode 3)

When M1=1, M0=1, module works in mode 3	
Transmitting	N/A
Receiving	N/A
Parameter setting	This mode can be used for parameter setting. It uses serial port 9600 & 8N1 to set module working parameters through specific instruction format. (pls refer to parameters setting for details)
Notes	When the mode changes from stand-by mode to others, the module will reset its parameters, during which the AUX keeps low level and then outputs high level after reset completed. It is recommended to check the AUX rising edge for user.

7 Command format

In sleep mode (Mode 3 : M1=1, M0=1) , it supports below instructions on list.

(Only support 9600 and 8N1 format when setting)

No.	Instruction format	Illustration
1	C0+working parameters	C0 + 5 bytes working parameters are sent in hexadecimal format. 6 bytes in total and must be sent in succession, (Save the parameters when power-down).
2	C1+C1+C1	(Save the parameters when power-down)
3	C2+working parameters	Three C1 are sent in hexadecimal format. The module returns the saved parameters and must be sent in succession.
4	C3+C3+C3	C2 + 5 bytes working parameters are sent in hexadecimal format. 6 bytes in total and must be sent in succession. (Do not save the parameters when power-down)
5	C4+C4+C4	Three C3 are sent in hexadecimal format. The module returns the version information and they must be sent in succession.

7.1 Default parameters

Default parameter values: : C0 00 00 1A 17 44

Model	Frequency	Address	Channel	Air data rate	Baud rate	Parity	Transmitting power
E32-433T30D	433MHz	0x0000	0x17	2.4kbps	9600	8N1	1W

7.2 Reading operating parameters

Instruction format	Description
C1+C1+C1	In sleep mode (M0=1, M1=1), User gives the module instruction (HEX format): C1 C1 C1, Module returns the present configuration parameters. For example, C0 00 00 1A 17 44.

7.3 Reading version number

Instruction format	Description
C3+C3+C3	In sleep mode (M0=1, M1=1), User gives the module instruction (HEX format): C3 C3 C3, Module returns its present version number, for example C3 32 xx yy. the second bytes means frequency. 32 here means the frequency is 433MHZ, 38 means frequency is 470MHz, 45 means frequency is; 868MHz, 44 means the frequency is 915 MHz, 46 means the frequency is 170MHz; xx is the version number and yy refers to the other module features.

7.4 Reset command

Instruction format	Description
C4+C4+C4	In sleep mode (M0=1, M1=1), User gives the module instruction (HEX format): C4 C4 C4, the module resets for one time. During the reset process, the module will conduct self-check, AUX outputs low level. After reset completing, the AUX outputs high level, then the module starts to work regularly which the working mode can be switched or be given another instruction.

7.5 Parameter setting command

No.	Item	Description	Remark
0	HEAD	Fix 0xC0 or 0xC2, it means this frame data is control command	<ul style="list-style-type: none"> Must be 0xC0 or 0xC2 C0: Save the parameters when power-down C2: Do not save the parameters when power-down
1	ADDH	High address byte of module (the default 00H)	00H-FFH
2	ADDL	Low address byte of module (the default 00H)	00H-FFH
3	SPED	7 6	<ul style="list-style-type: none"> UART mode can be different between communication parties
		0 0	

		0	1	801		<ul style="list-style-type: none"> ● UART baud rate can be different between communication parties ● The UART baud rate has nothing to do with wireless transmission parameters & won't affect the wireless transmit / receive features. 	
		1	0	8 E1			
		1	1	8N1 (equal to 00)			
		5	4	3	TTL UART baud rate (bps)		
		0	0	0	1200		
		0	0	1	2400		
		0	1	0	4800		
		0	1	1	9600 (default)		
		1	0	0	19200		
		1	0	1	38400		
		1	1	0	57600		
		1	1	1	115200		
		2	1	0	Air data rate (bps)		<ul style="list-style-type: none"> ● The lower the air data rate, the longer the transmitting distance, better anti-interference performance and longer transmitting time ● The air data rate must keep the same for both communication parties.
		0	0	0	0.3k		
		0	0	1	1.2k		
		0	1	0	2.4k (default)		
		0	1	1	4.8k		
		1	0	0	9.6k		
		1	0	1	19.2k		
		1	1	0	19.2k (same to 101)		
1	1	1	19.2k (same to 101)				
		General Specifications			Except for E32 (400T20S)		
4	CHAN	7	6	5	reserved	Write 0	
		Communication channel			00H-1FH, correspond to 410~441MHz		
		4-0, channel (410M + CHAN*1M), default 17H (433MHz)					
5	OPTION	7	Fixed transmission enabling bit (similar to MODBUS)			<ul style="list-style-type: none"> ● In fixed transmission mode, the first three bytes of each user's data frame can be used as high/low address and channel. The module changes its address and channel when transmit. And it will revert to original setting after complete the process. 	
		0	Transparent transmission mode				
		1	Fixed transmission mode				
		6	IO drive mode (default 1)			<ul style="list-style-type: none"> ● This bit is used to the module internal pull-up resistor. It also increases the level's adaptability in case of open drain. But in some cases, it may need external pull-up resistor. 	
		1	TXD and AUX push-pull outputs, RXD pull-up inputs				
		0	TXD、 AUX open-collector outputs, RXD open-collector inputs				
		5	4	3	wireless wake-up time		
		0	0	0	250ms (default)		<ul style="list-style-type: none"> ● The transmit & receive module work in mode 0, whose delay time is

0	0	1	500ms	invalid & can be arbitrary value. <ul style="list-style-type: none"> The transmitter works in mode 1 can transmit the preamble code of the corresponding time continuously. When the receiver works in mode 2, the time means the monitor interval time (wireless wake-up). Only the data from transmitter that works in mode 1 can be received.
0	1	0	750ms	
0	1	1	1000ms	
1	0	0	1250ms	
1	0	1	1500ms	
1	1	0	1750ms	
1	1	1	2000ms	
2	FEC switch			<ul style="list-style-type: none"> After turn off FEC, the actual data transmission rate increases while anti-interference ability decreases. Also the transmission distance is relatively short. Both communication parties must keep on the same pages about turn-on or turn-off FEC.
0	Turn off FEC			
1	Turn on FEC (default)			
1	0	Transmission power (approximation)		The external power must make sure the ability of current output more than 250mA and ensure the power supply ripple within 100mV. Low power transmission is not recommended due to its low power supply efficiency.
0	0	30dBm (default)		
0	1	27dBm		
1	0	24dBm		
1	1	21dBm		

For example: The meaning of No.3 "SPED" byte:

The binary bit of the byte	7	6	5	4	3	2	1	0
Configures by user	0	0	0	1	1	0	1	0
Meaning	UART parity bit 8N1		UART baud rate is 9600			Air data rate is 2.4k		
Corresponding hexadecimal	1				A			

8. Hardware design

- It is recommended to use a DC stabilized power supply. The power supply ripple factor is as small as possible, and the module needs to be reliably grounded. ;
- Please pay attention to the correct connection of the positive and negative poles of the power supply. Reverse connection may cause permanent damage to the module ;
- Please check the power supply to ensure it is within the recommended voltage otherwise when it exceeds the maximum value the module will be permanently damaged ;
- Please check the stability of the power supply, the voltage can not be fluctuated frequently ;
- When designing the power supply circuit for the module, it is often recommended to reserve more than 30% of the

margin, so the whole machine is beneficial for long-term stable operation. ;

- The module should be as far away as possible from the power supply, transformers, high-frequency wiring and other parts with large electromagnetic interference. ;
- High-frequency digital routing, high-frequency analog routing, and power routing must be avoided under the module. If it is necessary to pass through the module, assume that the module is soldered to the Top Layer, and the copper is spread on the Top Layer of the module contact part(well grounded), it must be close to the digital part of the module and routed in the Bottom Layer ;
- Assuming the module is soldered or placed over the Top Layer, it is wrong to randomly route over the Bottom Layer or other layers, which will affect the module's spurs and receiving sensitivity to varying degrees ;
- It is assumed that there are devices with large electromagnetic interference around the module that will greatly affect the performance. It is recommended to keep them away from the module according to the strength of the interference. If necessary, appropriate isolation and shielding can be done ;
- Assume that there are traces with large electromagnetic interference (high-frequency digital, high-frequency analog, power traces) around the module that will greatly affect the performance of the module. It is recommended to stay away from the module according to the strength of the interference. If necessary, appropriate isolation and shielding can be done.
- If the communication line uses a 5V level, a 1k-5.1k resistor must be connected in series (not recommended, there is still a risk of damage) ;
- Try to stay away from some physical layers such as TTL protocol at 2.4GHz , for example: USB3.0 ;
- The mounting structure of antenna has a great influence on the performance of the module. It is necessary to ensure that the antenna is exposed, preferably vertically upward. When the module is mounted inside the case, use a good antenna extension cable to extend the antenna to the outside ;
- The antenna must not be installed inside the metal case, which will cause the transmission distance to be greatly weakened.

9 FAQ

9.1 Communication range is too short

- The communication distance will be affected when obstacle exists.
- Data lose rate will be affected by temperature, humidity and co-channel interference.
- The ground will absorb and reflect wireless radio wave, so the performance will be poor when testing near ground.
- Sea water has great ability in absorbing wireless radio wave, so performance will be poor when testing near the sea.
- The signal will be affected when the antenna is near metal object or put in a metal case.
- Power register was set incorrectly, air data rate is set as too high (the higher the air data rate, the shorter the distance).
- The power supply low voltage under room temperature is lower than 2.5V, the lower the voltage, the lower the transmitting power.
- Due to antenna quality or poor matching between antenna and module.

9.2 Module is easy to damage

- Please check the power supply source, ensure it is 3.3V~5.2V, voltage higher than 5.2V will damage the module.
- Please check the stability of power source, the voltage cannot fluctuate too much.
- Please make sure antistatic measure are taken when installing and using, high frequency devices have electrostatic susceptibility.
- Please ensure the humidity is within limited range, some parts are sensitive to humidity.
- Please avoid using modules under too high or too low temperature.

9.3 BER(Bit Error Rate) is high

- There are co-channel signal interference nearby, please be away from interference sources or modify frequency and channel to avoid interference;
- Poor power supply may cause messy code. Make sure that the power supply is reliable.
- The extension line and feeder quality are poor or too long, so the bit error rate is high;

10 Production guidance

This type is DIP module, when the welder welds the module, he must be welding according to the anti-static regulation. This product is allergic to static, randomly welding the module will have the chance of damaging it permanently.

11 E32 series

Model No.	Core IC	Frequency Hz	Tx power dBm	Distance km	Data Rate	Package	Size mm	Interface
E32-868T20S	SX1276	868M	20	3	0.3k~19.2k	SMD	16 * 26	UART
E32-915T20S	SX1276	915M	20	3	0.3k~19.2k	SMD	16 * 26	UART
E32-400T20S	SX1278	433M 470M	20	3	0.3k~19.2k	SMD	16 * 26	UART
E32-915T30S	SX1276	915M	30	8	0.3k~19.2k	SMD	25 * 40.3	UART
E32-868T30S	SX1276	868M	30	8	0.3k~19.2k	SMD	25 * 40.3	UART
E32-433T30S	SX1278	433M	30	8	0.3k~19.2k	SMD	25 * 40.3	UART
E32-433T20S2T	SX1278	433M	20	3	0.3k~19.2k	SMD	17 * 30	UART
E32-868T30D	SX1276	868M	30	8	0.3~19.2k	DIP	24 * 43	SMA-K
E32-915T30D	SX1276	915M	30	8	0.3~19.2k	DIP	24 * 43	SMA-K
E32-170T30D	SX1278	170M	30	8	0.3k~9.6k	DIP	24 * 43	SMA-K
E32-868T20D	SX1276	868M	20	3	0.3~19.2k	DIP	21 * 36	SMA-K
E32-915T20D	SX1276	915M	20	3	0.3~19.2k	DIP	21 * 36	SMA-K
E32-433T20DC	SX1278	433M	20	3	0.3k~19.2k	DIP	21 * 36	SMA-K
E32-433T30D	SX1278	433M	30	8	0.3k~19.2k	DIP	24 * 43	SMA-K

E32-433T27D	SX1278	433M	27	5	0.3k~19.2k	DIP	24 * 43	SMA-K
E32-433T20S1	SX1278	433M	20	3	0.3k~19.2k	SND	17 * 25.5	SMA-K

12 Antenna recommendation

The antenna is an important role in the communication process. A good antenna can largely improve the communication system. Therefore, we recommend some antennas for wireless modules with excellent performance and reasonable price.

Model No.	Type	Frequency Hz	Interface	Gain dBi	Height	Cable	Function feature
TX433-NP-4310	Soft PCB antenna	433M	SMA-J	2	43.8*9.5mm	-	Soft inside, FPC soft antenna
TX433-JW-5	Rubber antenna	433M	SMA-J	2	50mm	-	Flexible & omnidirectional
TX433-JWG-7	Rubber antenna	433M	SMA-J	2.5	75mm	-	Flexible & omnidirectional
TX433-JK-20	Rubber antenna	433M	SMA-J	3	210mm	-	Flexible & omnidirectional
TX433-JK-11	Rubber antenna	433M	SMA-J	2.5	110mm	-	Flexible & omnidirectional
TX433-XP-200	Sucker antenna	433M	SMA-J	4	19cm	200cm	Sucker antenna, High gain
TX433-XP-100	Sucker antenna	433M	SMA-J	3.5	18.5cm	100cm	Sucker antenna, High gain
TX433-XP-300	Sucker antenna	433M	SMA-J	6	96.5cm	300cm	Car Sucker antenna, High gain
TX433-JZG-6	Rubber antenna	433M	SMA-J	2.5	52mm	-	Short straight & omnidirectional
TX433-JZ-5	Rubber antenna	433M	SMA-J	2	52mm	-	Short straight & omnidirectional
TX490-XPL-100	Sucker antenna	490M	SMA-J	3.5	12cm	100cm	Sucker antenna, High gain
TX490-JZ-5	Rubber antenna	490M	SMA-J	2	50mm	-	Short straight & omnidirectional

13 Package for batch order

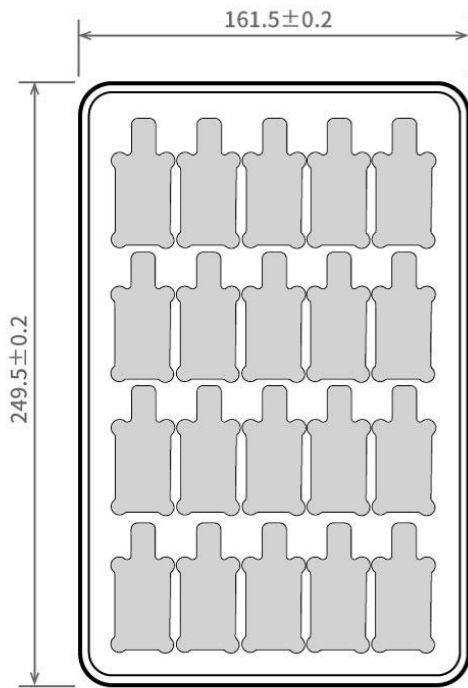

Unit: mm
Each Layer: 20 pcs
Each Package: 5 layers

Revision history

Version	Date	Description	Issued by
1.00	2017-11-10	Initial version	huaa
1.10	2018-01-11	Updating E32 (868T30S)/E32 (915T30S)	huaa
1.20	2018-01-15	Updating E32 (868T20S)/E32 (915T20S)/ E32 (400T20S)	huaa
1.30	2018-01-22	Updating E32 (868T20D)/ E32 (868T30D) E32 (915T20D)/ E32 (915T30D)/ E32 (170T30D)	huaa
1.40	2018-05-24	Updating antenna option	huaa
1.50	2018-10-11	Manual dividing	huaa
1.60	2020-04-13		Ren
1.8	2020-10-23	Parameter correction	Linson

About us

Technical support: support@cdebyte.com

Documents and RF Setting download link: www.ebyte.com

Thank you for using Ebyte products! Please contact us with any questions or suggestions: info@cdebyte.com

Fax: 028-64146160 ext. 821

Web: www.ebyte.com

Address: BuildingB5,MouldIndustrialPark,199#XiquAvenue,Chengdu,Sichuan



Chengdu Ebyte Electronic Technology Co.,Ltd.